



**Nest Protect (Wired 230V ~ 50Hz)
Detects smoke and carbon monoxide (CO)**

User's Guide

ATTENTION: Please read carefully and save this User's Guide in a safe place.

TABLE OF CONTENTS

Meet your Nest Protect	3
Location in your home	5
Placement on the ceiling or wall	6
Placement on a sloped ceiling	7
Setup and installation	8
Operating instructions	14
Heads-Up and Emergency Alarms	16
Wireless interconnect	17
Testing Nest Protect	18
General maintenance	19
Safety	22
Alarm limitations	22
Installation code	24
AC installation warnings	25
Installation in Ireland	27
Carbon monoxide (CO) precautions	29
What to do in case of a carbon monoxide alarm	30
Fire safety precautions	31
Mobile notifications	31
EU Declaration of Conformity	32
Limited Warranty	33

WE TAKE YOUR PRIVACY SERIOUSLY

We're committed to being open and honest about how we use data. We will always ask for permission before sharing your personally identifiable information such as your email address. We also keep your data safe with industry-standard security tools. To learn more about our Privacy Policy, please go to nest.com/eu/privacy.



0086-CPR-599229

MEET YOUR NEST PROTECT

Inside the box you'll find:



Nest Protect

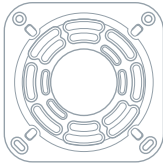

Backplate



4 mounting screws



Terminal blocks



230V AC cable connector

Nest Protect is designed to detect smoke and carbon monoxide in a residential environment. It has multiple sensors to help it understand what's happening in your home and a photoelectric sensor to detect slow, smoldering fires. Nest Protect can be used as a single station or multiple station alarm.

The installation of this apparatus should be carried out by a competent person.

This guide covers the installation of Nest Protect (Wired 230V) – Model number O5C-E.

REQUIREMENTS

Wi-Fi, an iOS or Android smartphone or tablet, and a free Nest Account are required for wireless mobile notifications and software updates. During setup, Wi-Fi and a free Nest Account are required for wireless interconnect and room naming. Once all the Nest Protects in your home are connected, they can communicate with each other without Wi-Fi.



13.4 cm
(5.28")

4.1 cm
(1.63")

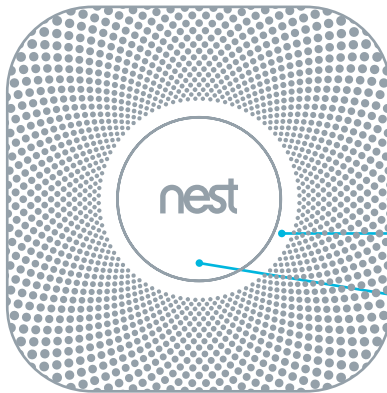

Horn enables Nest Protect to alert you with a loud emergency sound.

Speaker allows Nest Protect to speak with a human voice.

Light ring changes colour to alert you.

Push the Nest button to silence alarms and run a test.

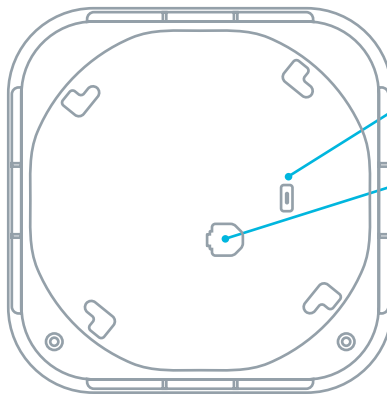

Micro-USB connector (for service only).

AC connector pins for the 230V cable connector.

Backup battery compartment:
3 AA Energizer® Ultimate Lithium batteries (L91).

LOCATION IN YOUR HOME

It is recommended that you place at least one smoke alarm on every floor of a dwelling, and a carbon monoxide detector in at least every room with a fuel burning appliance.

The Nest Protect smoke and carbon monoxide alarm should be installed:

- On every floor (required by law for smoke alarms).
- In every room containing a fuel burning appliance (recommended for CO alarms).
- In every sleeping room.
- In remote rooms that are used often but may be too far away to hear an alarm.
- Outside of unused rooms, like the boiler room.

Nest Protect should be installed at least 3 m (10 ft) away from cooktops or cooking appliances.
Nest Protect should NOT be installed in unfinished attics or garages.

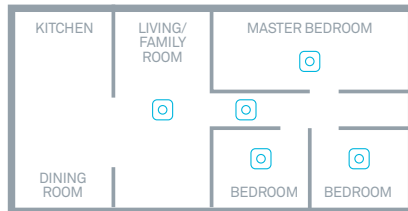
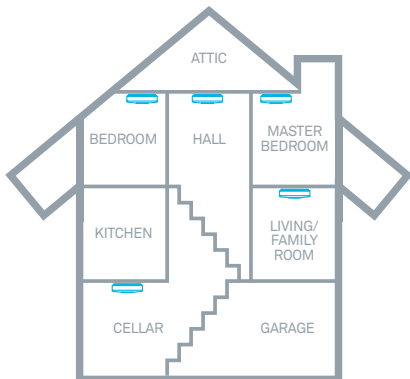

PLACEMENT ON THE CEILING OR WALL

Installing on the ceiling is recommended. Mark where the screws will go using the backplate as a guide. Make sure it's at least 30 cm (12 in) away from the wall.

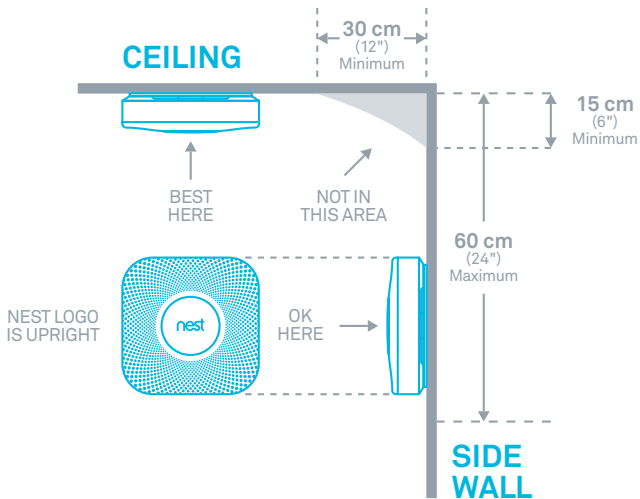

Figure 1

PLACEMENT ON A SLOPED CEILING

If you have a sloped, pitched or cathedral ceiling, Nest Protect should be 90 cm (35 in) from the highest peak.

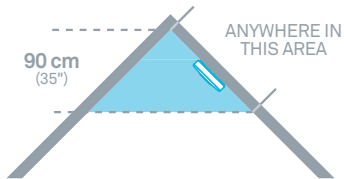

Figure 2

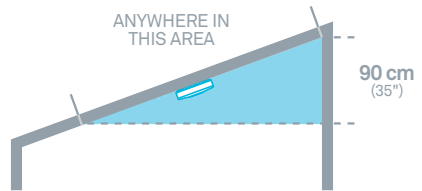

Figure 3

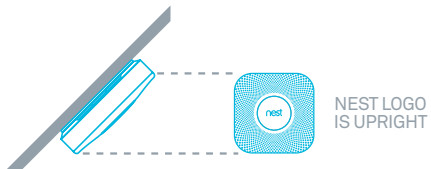

Figure 4

SETUP AND INSTALLATION

(Professional installation recommended)

The installation of a smoke/CO alarm should be made by a qualified technician, and all wiring used to install this alarm should be made in accordance with the British National Electrical Code, the British Standard BS 7671, with appropriate national electrical installation regulations and/or applicable codes in your local jurisdiction. Permanent connection to the fixed wiring of the building should be made in a suitable junction box.

For a complete set of instructions and warnings, refer to page 24.

Tip: Lay everything out on a table for easy installation.

1. Get the Nest app

Before you install your Nest Protect on the ceiling or wall, you'll need to set it up with the Nest app. Download the app from the Apple App Store, Google Play or the Amazon App Store and create a free Nest Account.



2. Set up Nest Protect with the Nest app

The Nest app will guide you through each step: scanning the Nest Protect QR code, connecting it to the Internet, and connecting it to other Nest Protects in your home.

Watch the video at nest.com/eu/installprotect.

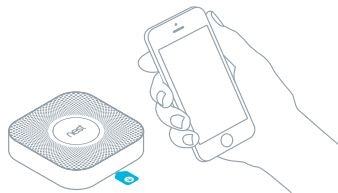

3. Have more Nest Protects?

The Nest app will ask you if you have additional Nest Protects to set up. If so, it'll take you through a shorter setup. Make sure to keep track of which Protects you've already set up and where you're going to install them.

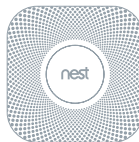

Already Added

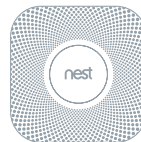

New

4. Test before you install

Once you're done setting up all of your Nest Protects, test they're added to your Nest Account by pushing the Nest button on one Nest Protect and follow the instructions to test. If they're all added, every Nest Protect will speak up.

Now you can install them on the ceiling or wall.

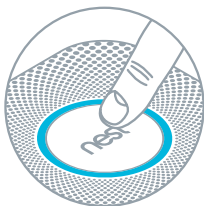

5. Turn off power

Protect yourself and avoid blowing a fuse. Switch off the correct circuit breaker or remove the fuse from the fuse box.

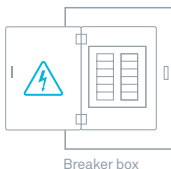

WARNING

ELECTRICAL SHOCK HAZARD

Failure to turn off the power may result in serious electrical shock, injury and death.

6. Remove your old smoke alarm

Make sure the green power light on the old smoke alarm is off then safely remove the old smoke alarm from its backplate – it'll be connected to some cables.

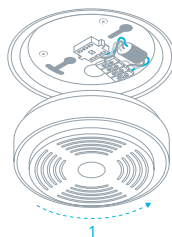

7. Disconnect all cables from the old backplate

There will be two or four conductors attached to the old backplate. Disconnect them all.

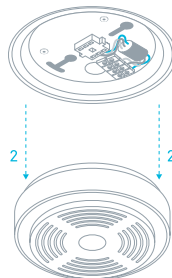

8. Remove the old backplate

Unscrew the backplate from the ceiling or dry lining box. You'll see one or two cables coming from your ceiling.

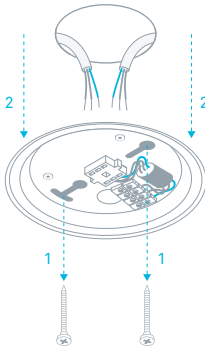

9. Connect the cables

Each cable from the ceiling or wall contains three or four differently coloured conductors. Wiring colours may vary based on the age of the wirings.

Live conductor (brown or marked L)



Neutral conductor (blue or marked N)



Earth conductor (yellow and green) if present



Interconnect conductor (usually black) if present



Match the live conductors coming from your ceiling to the live conductors in Nest's 230V AC cable connector and put them into a terminal block.

All the neutral conductors go into another terminal block, and the earth conductors into a third terminal block. There is no need for the interconnect cable as all Nest Protects are wirelessly interconnected. If there's an interconnect conductor, insulate it.

▲ WARNING

Mixing the live and neutral connections when interconnecting alarms will damage all the alarms – ensure that the same colours are used throughout the premises for live, neutral and interconnect cables (if present).

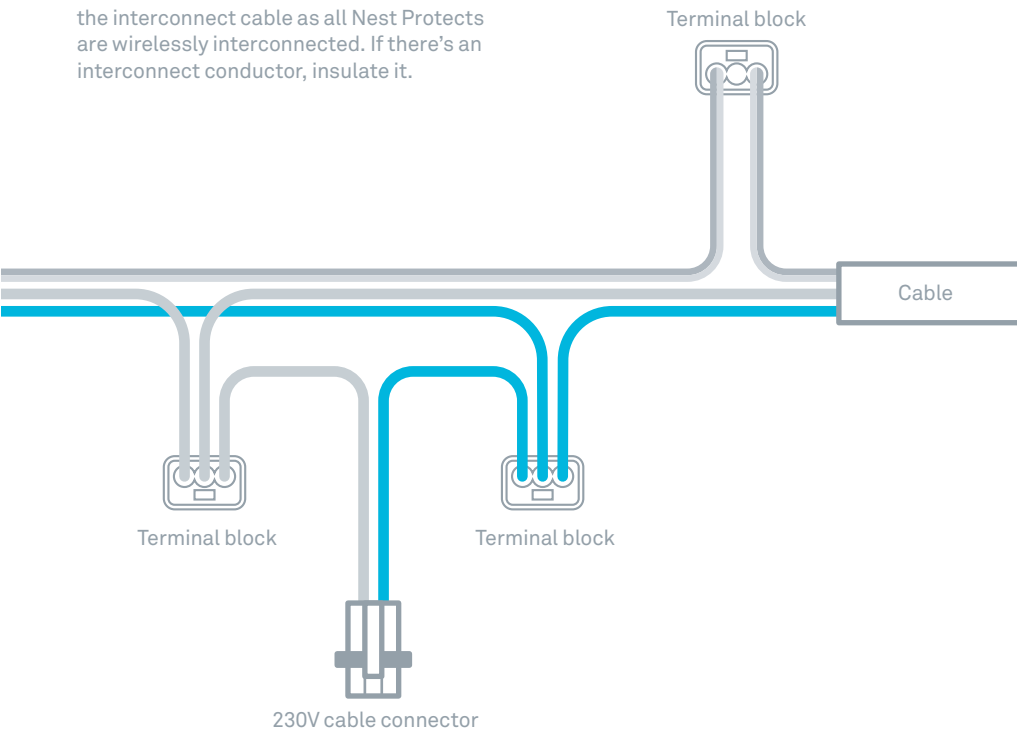

10. Install Nest Protect backplate

Screw the backplate to the existing electrical box, reusing the existing screws. (You can also screw the plate directly into the wall or ceiling with the Nest screws.)

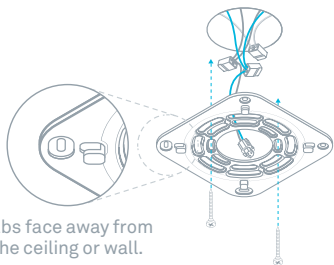

Tabs face away from the ceiling or wall.

▲ WARNING

Be sure to prevent dust from getting into Nest Protect. Put the dust cover back on, or keep it in a separate room while you drill and install the backplate. Clean any remaining dust before you mount Nest Protect.

11. Connect power

Plug the 230V cable connector into the back of Nest Protect.

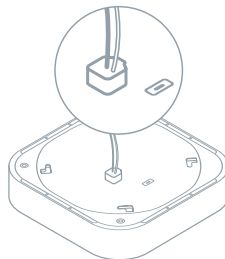

12. Mount your Nest Protect

Firstly, tuck any excess wiring into the electrical box and push Nest Protect onto the backplate.

Give it a slight twist clockwise. It'll CLICK into place.

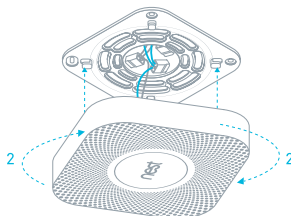

13. Switch power back on or replace the fuse



Breaker box

14. Press to test

Press the Nest button on one Nest Protect and follow the spoken instructions to test.



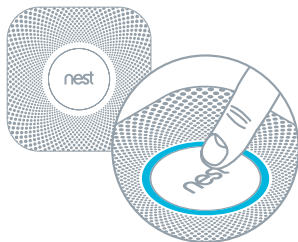

They should all speak to you, confirming that they're in range of each other.









OPERATING INSTRUCTIONS

When the Nest Protect smoke and carbon monoxide (CO) alarm has something to say, it will speak to you in words and colours instead of just beeping. It has two kinds of alerts: Heads-Up and Emergency Alarms.

- Nest Protect can see smoke or carbon monoxide levels rising. So before it turns on an Emergency Alarm, Nest Protect gives you a friendly spoken Heads-Up to warn you in advance. It pulses yellow and speaks to you, telling you what and where the danger is.
- When smoke or carbon monoxide reach dangerous levels, Nest Protect tells you where the emergency is and pulses red, in addition to making a loud alarm sound. This is an Emergency Alarm.

	WHAT YOU HEAR	WHAT YOU SEE ON NEST PROTECT	WHAT IT MEANS	WHAT TO DO
SETUP	"READY. PRESS TO TEST."	 BLUE rotates.	To set up or run a manual test.	Press the Nest button. Nest Protect will walk you through next steps.
	"BE AWARE, THERE'S SMOKE IN THE (ROOM NAME). THE ALARM MAY SOUND."	 YELLOW pulses.	Smoke levels are rising.	Stand under Nest Protect and press the Nest button to silence the alert. Then put out the source of the smoke.
	"BE AWARE, THERE'S CARBON MONOXIDE IN THE (ROOM NAME). THE ALARM MAY SOUND."	 YELLOW pulses.	Carbon monoxide levels are rising. This Heads-Up will occur if carbon monoxide levels stay at 70 ppm for 1 to 4 hours.	Stand under Nest Protect and press the Nest button to silence the alarm. Open a window or door to get fresh air, then find the CO leak and stop it.
	(ALARM SOUND) "EMERGENCY. THERE'S SMOKE IN (ROOM NAME)."	 RED pulses.	The smoke in the room has reached emergency levels.	Get out of the house immediately.
ALERTS	(ALARM SOUND) "EMERGENCY. THERE'S CARBON MONOXIDE IN (ROOM NAME). MOVE TO FRESH AIR NOW."	 RED pulses.	The carbon monoxide in the room has now reached emergency levels.	<ol style="list-style-type: none"> 1) Keep calm and open all doors and windows. 2) Stop using all fuel-burning appliances and ensure that they are turned off. 3) Evacuate the premises if the CO alarm continues to sound. 4) Call 999 or the fire brigade from outside.

	WHAT YOU HEAR	WHAT YOU SEE ON NEST PROTECT	WHAT IT MEANS	WHAT TO DO
EVERY DAY		 GREEN light above the Nest logo.	Nest Protect is working. The green light means AC power is connected.	
		 You turn off the room lights for the night, and the GREEN light pulses once.	Nest Protect has tested its sensors and batteries to confirm they are working correctly. This is Nightly Promise.	Sleep well.
		 WHITE light.	Pathlight lights your way at night as you pass under it.	
SILENCING	"SMOKE ALARM SILENCED."	 YELLOW or RED pulses.	You've silenced an alert. Nest Protect will now keep quiet, unless smoke or carbon monoxide reach dangerous levels.	Make sure you're safe and have put out the source of smoke or carbon monoxide.
	"CARBON MONOXIDE ALARM SILENCED."			
TROUBLE SIGNALS	"THE BATTERY IS LOW IN THE (ROOM NAME). REPLACE THE BATTERY SOON."	 YELLOW pulses.	Low battery.	Change the batteries of Nest Protect soon.
	"THE BATTERY IS VERY LOW IN THE (ROOM NAME). REPLACE THE BATTERY NOW." SINGLE CHIRP EVERY 60 SECONDS.	 YELLOW pulses.	Nest Protect batteries have been drained. It will chirp.	Change the batteries of Nest Protect now.
	"THE SENSORS HAVE FAILED IN THE (ROOM NAME). REPLACE NEST PROTECT NOW." SINGLE CHIRP EVERY 60 SECONDS.		Nest Protect has tested its sensors and there is a problem. It will chirp.	Clean with compressed air. If the problem persists, replace it.
	"NEST PROTECT HAS EXPIRED. REPLACE IT NOW." TWO CHIRPS EVERY 60 SECONDS.		Nest Protect has expired and reached its end of life.	Replace Nest Protect.

HEADS-UP AND EMERGENCY ALARMS

ALERTS

Nest Protect has two kinds of voice alerts: Heads-Up and Emergency Alarms. A Heads-Up is a friendly warning before conditions get dangerous. Nest Protect pulses yellow and tells you where smoke or carbon monoxide is.

An Emergency Alarm occurs when smoke or carbon monoxide reach dangerous levels. Nest Protect pulses red, makes a loud alarm sound and tells you which room the emergency is in. The smoke alarm takes precedence when carbon monoxide is also present.

WHICH ALERTS CAN BE SILENCED

- Heads-Up alerts can be silenced by pressing the Nest button.
- Emergency Alarms can be silenced by pressing the Nest button. For your safety, get out of the house immediately.
- Because there are many different types of fires, you may experience an Emergency Alarm without having first experienced a Heads-Up alert. This means that dangerous levels of smoke or CO occurred extremely quickly and Nest Protect must sound the Emergency Alarm.
- Once the Nest Protects in your home are connected to each other, whenever there's a Heads-Up or an Emergency Alarm, they will all tell you what and where the danger is. So go to that room and press the Nest button on the Nest Protect there to silence every Nest Protect in the home. This will ensure that you will identify the source of the danger in that room.

WIRELESS INTERCONNECT

Once your Nest Protects have been wirelessly connected, they'll all speak up at once in an emergency. That means when one Nest Protect raises any kind of alert, every Nest Protect in the house will tell you which room the smoke or CO is in. For example, if you're in the bedroom and the alarm goes off in the cellar, the Nest Protect in the bedroom will tell you there's smoke in the cellar. To silence the alert, go to that room and press the button on the Nest Protect there. That will silence every Nest Protect in the house.

Nest Protect's 230V connector does not have a cable for interconnect as it connects wirelessly. There's no need to connect any cable to the interconnect cable from the ceiling/wall.

Nest Protects can typically communicate with each other if they're 15 m (50 ft) apart inside a home. Some features of a home may reduce their range, including the number of floors, number/size of rooms, furniture, type of building material, suspended ceilings, ductwork, large metallic appliances and metal studs. This kind of interference can be overcome by adding more Nest Protects that can route wireless signals around obstructions.

Nest Protect - Battery (model number 05A-E, 05A-UK) and Nest Protect - Wired 230V (model number 05C-E, 05C-UK) are compatible and can be interconnected wirelessly.

Nest Protect wireless interconnect will not work with products from other brands.

▲ WARNING

- The range and proper operation of any wireless device will vary depending on its surroundings.
- Nest Protect alarms are not to be used outdoors or to transmit between buildings. The alarms will not communicate properly in those conditions.
- Metal objects and metallic wallpaper may interfere with signals from wireless alarms. Test your Nest Protects with metal doors opened and closed.

You can connect up to 18 interconnected Nest Protects to your Nest Account.

PATHLIGHT

Usually Nest Protect has its light turned off, but it will light your way as you walk underneath it in the dark. You can enable and disable Pathlight from the Nest Mobile app.

TESTING NEST PROTECT

SELF-MONITORING

Nest Protect continuously tests itself, so you don't have to wonder if it's working.

When you turn out the lights for the night, Nest Protect will glow green for a moment – that means everything is working. If it glows yellow, this means Nest Protect has detected something wrong that needs your attention. Just push the Nest button to hear its warning: either the batteries are low, Wi-Fi has been down or there is an issue with its sensors.

TEST NEST PROTECT MANUALLY

Regulations require a weekly manual test.

After installation, test Nest Protect by pressing the Nest button twice. Before sounding the alarm, Nest Protect will give you a countdown so that you have time to move away from the alarm.

▲ WARNING

DO NOT stand close to the alarm when the horn is sounding. Exposure at close range may be harmful to your hearing. When testing, step away when horn starts sounding.

Test procedure

- Press the Nest button twice to start a test.
- Nest Protect will say: "This is only a test. The alarm will sound."
- Once the Nest Protect you've tested has made sure it's working, it'll tell you everything's okay.

If they are interconnected, every Nest Protect in the house will speak up. Walk to each one to make sure you hear them.

▲ WARNING

- If the alarm fails to operate correctly, your Nest Protect will need servicing. Contact Nest Labs.
- DO NOT use a match, cigarette or any other makeshift fire to test the smoke alarm.
- To test the CO alarm, NEVER use vehicle exhaust or any other source of gas. Exhaust may cause permanent damage and voids your warranty.
- NEVER use a naked flame of any kind to test this alarm. You might accidentally damage or set fire to the unit or to your home.

GENERAL MAINTENANCE

CLEANING YOUR NEST PROTECT

Use a damp cloth to clean your Nest Protect. Don't clean it with detergents or solvents and do not spray air fresheners, hair spray or other aerosols near it. These chemicals will damage your smoke alarm and make it non-operational. Cleaning fluids, polishes, paints and cooking operations may affect the reliability of the smoke alarm. Do not disassemble your Nest Protect or clean inside it. If a continuous alarm occurs, return for servicing. Do not get water inside the alarm. Do not paint over Nest Protect, as paint will seal the vents and affect its ability to detect smoke and CO.

RESETTING NEST PROTECT

You can reset Nest Protect to erase all your settings and reset the wireless interconnection between Nest Protects. You may want to do this before you move to a new house. After resetting Nest Protect, it will still detect smoke and carbon monoxide.

To reset, refer to the complete instructions on nest.com/eu/protect/reset.

SOFTWARE VERSION

Follow these steps to check the Nest Protect software version:

1. Press and hold the button for at least 10 seconds.
2. You'll hear Nest Protect play a tone, then it will announce the software version number.
3. Let go of the button.
4. If you want to keep the current settings, press again to cancel erasing all settings.

You can also review the software version from the Nest App by checking the technical specifications of Nest Protect.

BACKUP BATTERY

3 AA Energizer® Ultimate Lithium batteries (L91). These backup batteries can be purchased from your local retailer.

Nest Protect will let you know its backup batteries are getting low before they need to be replaced. Instead of lighting up green during Nightly Promise, it'll glow yellow. Once you press the Nest button, Nest Protect will say, "The battery is low. Replace it soon."

In case of power outage, Nest Protect uses long-life backup lithium batteries designed to last multiple years of operation. Battery life depends on usage.

▲ WARNING

Use only batteries specified by Nest. Use of a different battery model will have a detrimental effect on the smoke alarm operation. The alarm may not operate properly with other batteries. Never use rechargeable batteries since they may not provide a constant charge.

▲ WARNING

Never remove the batteries from a battery-operated alarm to stop an unwanted alarm (caused by cooking smoke, etc.). Removing batteries disables the alarm so it cannot sense smoke, leaving you at risk.

The alarm will not operate without battery power. The alarm cannot work until you install the batteries in the correct position (Match “+” to “+” and “-” to “-”).

This device contains lithium batteries. If tampered with, the battery may be short circuited and create a risk of fire. Never attempt to open or damage the alarm.

Replace all batteries at once and only use new, unused batteries as replacements.

REPLACING THE BACKUP BATTERIES

1. Remove your Nest Protect from its backplate.
2. Using a Phillips screwdriver, unscrew the two screws from the battery door on the back of Nest Protect.



3. Replace the batteries. Make sure to use Energizer Ultimate Lithium batteries and install them in the right order. If you install them out of order, you may not be able to close the battery compartment.

1. First battery
2. Second battery
3. Third battery. This battery will push the bracket into place.

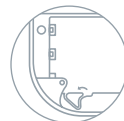
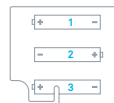

4. Reattach the battery door by sliding it into the tabs located on the opposite side from the batteries, replacing the screws and then reattaching Nest Protect to the backplate.

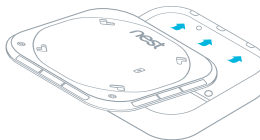

5. Press the Nest button to run a test.

SERVICING

Step 1: Before sending Nest Protect for service, review the information at nest.com/eu/support.

Step 2: Contact our support team to get a return number.

Step 3: Send it to

Nest Labs

(YOUR RETURN NUMBER)

Arvato Distribution GmbH – Technology

Willi-Bleicher-Str. 36

52353 Düren

Germany

RECYCLING AND DISPOSAL

Visit nest.com/eu/recycle.

Dispose in accordance with applicable legislation.



The WEEE symbol means that your Nest Protect must be disposed of separately from general household waste. When Nest Protect reaches its end of life, take it to a designated waste collection point in your area for safe disposal or recycling. By doing this, you'll conserve natural resources, protect human health and help the environment.

NEST AND THE ENVIRONMENT

Nest recognises its responsibility to minimise the environmental impacts of its operations and products. More information is available on the web at nest.com/eu/responsibility.

EXPIRATION

Nest Protect has a limited life like any smoke/CO alarm. Nest Protect's lifetime is 7 years. You will need to replace Nest Protect after 7 years with a brand new Nest Protect. Check the date of replacement written on the back of Nest Protect.

▲ WARNING

You'll no longer be protected from smoke or CO if you don't replace your Nest Protect.

About two weeks before it expires, Nest Protect will light up with a yellow light. Press the Nest button and it will say, "Nest Protect has expired. Replace it now." Buy a new alarm and recycle the expired one. Make sure you test your new Nest Protect once it's installed.

TECHNICAL SPECIFICATIONS

- Temperature range: 4 °C (40 °F) to 38 °C (100 °F).
- Humidity range: 20% RH to 80% RH (non condensing).
- Nest Protect (Wired) uses 230V ~50Hz.

SAFETY

ALARM LIMITATIONS

LIMITATIONS OF SMOKE ALARMS

Alarms reduce deaths resulting from home fires worldwide. However smoke alarms can only work if they are properly located, installed and maintained, and if smoke reaches the alarms.

- Smoke alarms may not waken all individuals. Make sure you create an escape plan and you practice fire drills with all members of the family.
- Smoke alarms cannot work without power. If they are powered by batteries, the smoke alarms cannot work if the batteries are missing, dead or disconnected. If they are wired, the smoke alarms cannot work during a long power outage once the back up battery is dead. Nest Protect will warn you in advance when batteries are running low so that you can replace them.
- Smoke will not be able to reach the smoke sensor while the dust cover is in place. The dust cover must be removed.
- Smoke alarms cannot detect fires if the smoke does not reach the alarms. For example, if a door is closed, smoke may not reach the smoke alarm. This is why you should have a smoke alarm in each bedroom and in the hallways as bedroom doors may be closed at night.
- Smoke alarms may not be heard. Although the smoke alarm comes with a loud horn of 85 decibels, it may not be heard if : 1) people have consumed alcohol or drugs, 2) the alarm is drowned by noise from a stereo, TV, traffic, air conditioner or other appliances, 3) residents are hearing impaired or have high frequency hearing loss associated with

ageing. Special smoke alarms should be installed for those who are hearing impaired.

- This smoke alarm is not intended to alert hearing impaired residents. Alarms specifically designed for the hearing impaired, which feature devices like flashing strobe lights or low frequency devices are available to alert the hearing impaired in case of fire.
- This smoke alarm alone is not a suitable substitute for complete fire detection systems in places housing many people—like blocks of flats, condominiums, hotels, guest houses, halls of residence, hospitals, long-term health care facilities, nursing homes, day care facilities, or group homes of any kind—even if they were once single-family homes. It is not a suitable substitute for complete fire detection systems in warehouses, industrial facilities, commercial buildings, and special-purpose non-residential buildings which require special fire detection and alarm systems. Depending on the building codes in your area, this smoke alarm may be used to provide additional protection in these facilities.

LIMITATIONS OF CARBON MONOXIDE (CO) ALARMS

- NEVER ignore your carbon monoxide alarm if it sounds. Refer to “What to do in case of a carbon monoxide alarm” for more information. Failure to do so can result in injury or death.
- This CO alarm is designed for use inside a single-family home or apartment. It is not meant to be used in common lobbies, hallways, or cellars of multi-family buildings unless working CO alarms are also installed in each family living unit. CO alarms in common areas may not be heard from inside individual family living units.
- This CO alarm alone is not a suitable substitute for complete detection systems in places which house many people, like hotels or halls of residence, unless a CO alarm is also placed in each unit.
- DO NOT use this CO alarm in warehouses, industrial or commercial buildings, special-purpose non-residential buildings, or aeroplanes. This CO alarm is specifically designed for residential use, and may not provide adequate protection in non-residential applications.
- Some individuals are more sensitive to CO than others, including people with cardiac or respiratory problems, infants, unborn babies, pregnant mothers, or elderly people can be more quickly and severely affected by CO. Members of sensitive populations should consult their doctors for advice on taking additional precautions.
- The silence feature is for your convenience only and will not correct a CO problem. Always check your home for a potential problem after any alarm. Failure to do so can result in injury or death.

INSTALLATION CODE

Specific requirements for Smoke Alarm installation vary from country to country. Check with your local Fire Brigade for current requirements in your area.

▲ WARNING

Smoke alarms are designed to alert you with an audible alarm at a level specified by the British Standard BS EN 14604: 2005.

▲ WARNING

The smoke alarm accompanying this user's guide employs the latest technology and is independently tested as being compliant with all the relevant British Standards Institution. However, as with any electronic product it may fail and may not sense all types of fire within sufficient time to alert you of the danger and provide adequate time for your escape. In order to maximise your level of safety always test your smoke alarm frequently to ensure it is in full working order.

▲ WARNING

There is a risk of malfunction and electric shock if the alarm is tampered with.

Your smoke/CO alarm is only suitable for use in domestic residential applications as covered in this user's guide. It is not suitable for commercial or industrial applications. It is designed to sense smoke and carbon monoxide and alert you. It will not prevent or extinguish fires.

WHERE TO INSTALL A SMOKE ALARM

British Standards Institution (BSI) recommends the following installation.

Multi-family or mixed occupant residence (Tenancy building, student accommodation)

Your smoke/CO alarm can also be used in individual flats and bedsits, providing the same conditions are met as for a single-family residence. However, there must already be a primary fire detection system that meets regulatory requirements for common areas such as lobbies and hallways.

Institutions and Hotels

This includes guest houses, hospitals, day care facilities, long-term health care facilities, B&Bs and halls of residence. Your smoke/CO alarm can be used in individual sleeping/resident rooms, providing the same conditions are met as for a single-family residence. However, there must already be a primary fire detection system that meets regulatory requirements for common areas such as lobbies and hallways. Use of this smoke alarm in common areas may not provide sufficient fire warning to residents or meet regulatory requirements.

Commercial and Industrial Premises

This smoke alarm is not intended for any non-residential, commercial or industrial application, nor for any other purpose than described above.

AC INSTALLATION WARNINGS

SMOKE DETECTION

Are more smoke alarms desirable?

The required number of smoke alarms might not provide reliable early warning protection for those areas separated by a door from the areas protected by the required smoke alarms. For this reason, the use of additional smoke alarms for those areas is recommended for increased protection. The additional areas include the dining room and hallways not protected by the required smoke alarms. The installation of smoke alarms in kitchens, attics (finished or unfinished), or garages is not normally recommended, because these locations occasionally experience conditions that can result in improper operation. As Nest Protect is also a carbon monoxide alarm, it is not recommended to install it in a furnace room or a utility room if it contains a water heater or a boiler. It should be 5–6 m (15–20 ft) from these appliances to avoid transient conditions and/or perceived nuisance alarms.

ELECTRICAL SHOCK HAZARD

- Turn off power to the area where you will install this unit at the circuit breaker or fuse box before beginning installation. Failure to turn off the power before installation may result in serious electrical shock, injury or death.
- Do not restore power until all alarms are completely installed. Restoring power before installation is complete may result in serious electrical shock, injury or death.
- Turn off the power to the area where the alarm is installed before removing it from the mounting bracket. Failure to turn off the power first may result in serious electrical shock, injury or death.
- If any unit in the series does not alarm, TURN OFF POWER and recheck connections. If it does not alarm when you restore power, replace it immediately.
- Attempting to disconnect the power connector from the unit when the power is on may result in electrical shock, serious injury or death.
- Failure to meet any of the above requirements could damage the units and cause them to malfunction, removing your protection.
- Improper wiring of the power connector or the wiring leading to the power connector will cause damage to the alarm and may lead to a non-functioning alarm.
- This unit must be powered by a 24-hour, 230V AC pure sine wave, 50Hz circuit. Be sure the circuit cannot be turned off by a switch, dimmer, or ground fault circuit interrupter. Failure to connect this unit to a 24-hour circuit may prevent it from providing constant protection.

- The alarm cannot be operated from power derived from a square wave, modified square wave or modified sine wave inverter. These types of inverters are sometimes used to supply power to the structure in off-grid installations, such as solar or wind derived power sources. These power sources produce high peak voltages that will damage the alarm.
- Never disconnect the power from an AC powered unit to stop an unwanted alarm. Doing so will disable the unit and remove your protection. In the case of a true unwanted alarm open a window or fan the smoke away from the unit. The alarm will reset automatically when it returns to normal operation.
- Improper wiring of the power connector or the wiring leading to the power connector will cause damage to the alarm and may lead to a non-functioning alarm. You must test to ensure proper installation.
- There is a risk of electrical shock, if the smoke alarm is tampered in any ways.

WHERE NOT TO INSTALL YOUR SMOKE ALARMS

For best performance, AVOID installing a smoke alarm in these areas:

- **Where combustion particles are produced.** Burning material creates combustion particles which could cause your smoke alarm to go off unnecessarily. Areas to avoid include poorly ventilated kitchens, garages, boats, recreational vehicles and boiler rooms. Keep a smoke alarm at least 6 metres (20 feet) from from the source of combustion particles (stove, furnace, water heater, space heater) if possible. In areas where a 6-metre (20-foot) distance is

not possible – in mobile or smaller homes, for example – it is recommended a smoke alarm be placed as far from these fuel-burning sources as possible. The placement recommendations are intended to keep a smoke detector at a reasonable distance from a fuel-burning source, reducing “unwanted” alarms.

Unwanted alarms can occur if a smoke alarm is placed directly next to a fuel-burning source. Ventilate these areas as much as possible.

- **In air streams near kitchens.** Air currents can draw cooking smoke into the sensor of a smoke alarm near the kitchen.
- **In very damp, humid or steamy areas, or directly near bathrooms with showers.** Keep a smoke alarm at least 3 metres (10 feet) away from showers, saunas, dishwashers, etc.
- **Where temperatures are regularly below 4 °C (40 °F) or above 38 °C (100 °F)** including unheated buildings, outdoor rooms, porches, or unfinished attics or cellars.
- **In very dusty, dirty, or greasy areas.** Do not install a smoke alarm directly over the stove or range. Clean a laundry room unit frequently to keep it free of dust or lint.
- **Near fresh air vents, ceiling fans, or in very drafty areas.** Drafts can blow smoke away from a smoke alarm, preventing it from reaching the sensor.
- **In insect infested areas.** Insects can clog openings to the sensor and cause unwanted alarms.
- **Less than 30.5 cm (12 in) away from fluorescent lights.** Electrical “noise” can interfere with the sensor.
- **In “dead air” spaces.** “Dead air” spaces may prevent smoke from reaching a smoke alarm.

INSTALLATION IN IRELAND

WHERE NOT TO INSTALL YOUR CARBON MONOXIDE ALARMS

- Keep carbon monoxide alarm at least 1.5 m (5 ft) away from any cooking appliance including stovetop, oven, microwave, etc.
- This alarm should not be installed in locations where the temperature is below 4 °C (40 °F) or above 38 °C (100 °F).
- In a enclosed space (for example in a cupboard or behind a curtain).
- Where it can be obstructed (for example by furniture).
- Directly above a sink.
- Next to a door or window.
- Next to an extractor fan.
- Next to an air vent or other similar ventilation openings.
- Where dirt and dust may block the sensor.
- In a damp or humid location.

EXAMPLES OF WHEN YOUR SMOKE ALARM MAY NOT BE EFFECTIVE

Your alarm may not be effective in protecting against fire in certain cases:

- Smoking in bed.
- Leaving children unsupervised.
- Cleaning with flammable liquids, like gasoline.
- When someone's clothes have caught on fire.
- Fires where the smoke is prevented from reaching the alarm due to a closed door or other obstruction.

REGULATORY REQUIREMENTS

Nest Protect provides both smoke alarm and carbon monoxide alarm functionality. When appropriately installed, Nest Protect will enable you to comply with Irish regulatory requirements.

This document does not purport to provide guidance on legal requirements – reference should be made to the relevant legislation, the current edition of the National Rules for Electrical Installations (Wiring Rules), relevant standards and guidance documents.

Smoke alarm requirements

Nest Protect 230V is suitable for installation in both new and existing buildings. However, battery powered Nest Protects are not suitable in new buildings or where there is significant construction or change of use taking place. If in doubt, consult a registered electrical contractor.

You should install Nest Protect 230V to comply with Part B of the Building Regulations and the Technical Guidance document published under Part B. The Part B Technical Guidance requires the provision of a system complying with Part 6 of BS 5839 of 2004 and meeting at least the requirements of a Grade D system, as set out in BS 5839 Part 6. When properly installed, a system comprised of Nest Protect 230V units will meet this standard.

Carbon monoxide alarm requirements

If you are installing a new heat-producing appliance (fire, boiler, etc.) after 1 September 2014, Part J of the Building Regulations will require the installation of carbon monoxide alarms. While most building regulations apply only where there is new construction, an extension, or a significant change of use and only apply to the parts of the building affected, Part J applies whenever a heat producing appliance is installed or replaced. Carbon Monoxide alarms should be installed in accordance with the technical guidance document for Part J: www.environ.ie/en/Publications/Developmentandhousing/Buildingstandards/fileDownload,37240,en.pdf

INFORMATION FOR PRO INSTALLERS

Information in this section is intended for registered electrical contractors. It assumes that the reader is familiar with the Wiring Rules and is an Authorised Person, as defined in the Wiring Rules.

Chapter 56 of the Wiring Rules does not apply to domestic and similar premises (see rule 560.2). Accordingly, it is not necessary, amongst other things, that fire resistant supply cables be used in installing Nest Protect units.

Nest Protect 230V units incorporate battery backup. Accordingly, supply does not need to be derived from a dedicated circuit to comply with BS 5839 Part 6.

In existing installations, power supply to each interconnected mains powered smoke alarm may be derived from a local frequently used lighting circuit. Accordingly, multiple circuits may supply power to the smoke alarms in a single installation. Ensure that the power supply is disconnected at each such smoke alarm before starting work.

All circuits altered during Nest Protect installation should be tested following wiring of the Nest Protect units, in accordance with the Wiring Rules. Nest Protects may be damaged by the high voltages applied while testing wiring insulation resistance. Therefore, all Nest Protects should be removed from their backplates and disconnected from wiring before testing.

CARBON MONOXIDE (CO) PRECAUTIONS

WHAT IS CARBON MONOXIDE?

Carbon Monoxide (CO) is an invisible, odourless, tasteless gas produced when fuels do not burn completely, or are exposed to heat (usually fire). These fuels include: wood, coal, charcoal, oil, natural gas, gasoline, kerosene and propane.

Common appliances that are often sources of CO include oil or gas burning boilers, gas ovens, wood-burning fireplaces, and charcoal grills. If they are not properly maintained, are improperly ventilated or malfunction, CO levels can rise quickly. Additional sources include space and water heating, cooking, uncontrolled burning, tobacco smoking and internal combustion engines. CO is a real danger now that homes are more energy efficient. “Air-tight” homes with added insulation, sealed windows, and other weatherproofing can “trap” CO inside.

Electrical appliances typically do not produce CO.

SYMPTOMS OF CO POISONING

The following symptoms are related to CARBON MONOXIDE POISONING and are to be discussed with ALL members of the household:

- **Mild Exposure:** Slight headache, nausea, vomiting, fatigue (often described as ‘Flu-like’ symptoms).
- **Medium Exposure:** Severe throbbing headache, drowsiness, confusion, fast heart rate.
- **Extreme Exposure:** Unconsciousness, convulsions, cardiorespiratory failure, death.

- Many cases of reported CO POISONING indicate that while victims are aware they are not well, they become so disoriented they are unable to save themselves by either exiting the building or calling for assistance. Young children and household pets are typically the first affected.

▲ WARNING

This carbon monoxide alarm is designed to detect carbon monoxide from any source of combustion. It is NOT designed to detect any other gas.

Individuals with certain medical problems should consider using detection devices with lower COHb alarming capabilities and consider warning devices which provide audible and visual signals for carbon monoxide concentrations under 30 ppm.

Installation of the apparatus should not be used as a substitute for proper installation, use and maintenance of fuel burning appliances including appropriate ventilation and exhaust systems.

This apparatus is designed to protect individuals from the acute effects of carbon monoxide exposure. It will not fully safeguard individuals with specific medical conditions. If in doubt consult a medical practitioner.

WHAT TO DO IN CASE OF A CARBON MONOXIDE ALARM

▲ WARNING

Actuation of your CO alarm indicates the presence of carbon monoxide (CO) which can KILL YOU.

1. Keep calm and open all doors and windows to increase the rate of ventilation.
2. Stop using all fuel-burning appliances and ensure if possible that they are turned off.
3. Evacuate the premises if the carbon monoxide alarm continues to sound.
4. Contact your emergency services.

PHONE NUMBER:

5. Get medical help for anyone suffering the effects of carbon monoxide poisoning.
6. Call the appropriate appliance servicing and/or maintenance agency so that the source of the CO emissions can be identified and corrected. Do not use the fuel-burning appliances again, until they have been checked and cleared for use by a competent person according to national regulations.

THE FOLLOWING CONDITIONS CAN RESULT IN TRANSIENT CO SITUATIONS

1. Excessive spillage or reverse venting of fuel burning appliances caused by:
 - I) Outdoor ambient conditions such as wind direction and/or velocity, including high gusts of wind; heavy air in the vent pipes (cold/humid air with extended periods between cycles).
 - II) Negative pressure differential resulting from the use of exhaust fans.

- III) Simultaneous operation of several fuel burning appliances competing for limited internal air.
 - IV) Vent pipe connection vibrating loose from clothes dryers, boilers, or water heaters.
 - V) Obstructions in or unconventional vent pipe designs which amplify the above situations.
2. Extended operation of unvented fuel burning devices (range, oven, fireplace, etc.).
 3. Temperature inversions which can trap exhaust gases near the ground.
 4. Car idling in an open or closed attached garage, or near a home.
 5. NEVER bring a charcoal grill inside and ALWAYS operate a portable generator outside, a safe distance from the house, and well away from windows.

▲ WARNING

The following substances in high concentration can affect the carbon monoxide sensor and may affect the reliability of the alarm or cause false alarms: paints, thinners, solvents, adhesives, hair-sprays, some cleaning agents, ammonia, acetone, hydrogen methane, iso-butane, iso-propanol, ethylene, benzene, toluene, ethyl acetate, alcohol based products, volatile oils, silicone vapours, hydrogen sulphide, sulfuric acid, hair grooming products, high concentrations of dust and oil mist, soaking or splashing with water.

FIRE SAFETY PRECAUTIONS

CREATE AN ESCAPE PLAN TO PRACTICE

Be prepared when your smoke/CO alarm sounds its alarm. Develop a family escape plan, discuss it with all household members, and practice it regularly.

- Make sure everyone is familiar with the sound of your smoke/CO alarm and explain what the sound means.
- Determine TWO exits from each room and have an escape route to the outside from each exit.
- Teach all the members in your household to check doors for heat with the back of your hand before opening them, and to use the alternate exit if the door is hot. Make sure they do not open the door if it is hot.
- Teach household members to crawl along the floor to avoid dangerous smoke, fumes and gases.
- Determine a safe meeting place for all household members to regroup at outside the building.

PRACTICE FIRE SAFETY

Practice your escape plan at least twice a year, making sure that everyone is involved – from kids to grandparents. Practice the escape plan with children, including holding one at night when they are sleeping. If children or others do not wake up to the sound of the smoke alarm, or if there are infants or family members with mobility limitations, make sure that someone is assigned to help them for the fire drill and in the event of an emergency.

Current studies have shown smoke alarms may not awaken all sleeping individuals, and that it is the responsibility of individuals in the household that are capable of assisting others to provide assistance to those who may not be awakened by the alarm sound, or to those who may be incapable of safely evacuating the area unassisted.

WHAT TO DO IN CASE OF FIRE

- Get out now.
- Don't panic; stay calm.
- Operate your safety plan as previously planned.
- Alert small children in the home and those who may need extra assistance.
- Leave the building as quickly as possible. Touch doors with the back of your hand and make sure they are not hot before opening them. Use an alternate exit, if necessary. In case of smoke, crawl along the floor, and DO NOT stop to collect anything. Close the doors behind you.
- Assemble at a pre-arranged place outside the building.
- Once outside, do a head count and call the fire brigade.
- DO NOT re-enter the house, unless a fire officer says it's safe to re-enter.

MOBILE NOTIFICATIONS

▲ WARNING

Nest Protect smartphone and tablet notifications require a functional Wi-Fi connection. They're only as reliable as your home's Wi-Fi network and aren't a substitute for a third party emergency monitoring service.

This user's guide and the products described herein are copyrighted, with all rights reserved. Under these copyright laws, no part of this installation guide may be copied for use without the written consent of Nest.

Nest Labs (Europe) Ltd. is a subsidiary of Nest Labs, Inc., a US entity.

EU DECLARATION OF CONFORMITY

We, Nest Labs Inc. declare under our sole responsibility that this product complies with the essential requirements of the R&TTE Directive 1999/5/EC, the European Directives 2006/95/EC, 2004/108/EC, and 1999/5/EC.

This device meets the following conformance standards: EN 300 328, EN 301 489-1, EN 301 489-17, EN 55022, EN 55024, EN62311, EN61000-3-2, and EN61000-3-3.

Nest Labs Inc. declares that this smoke/CO alarm is in compliance with the essential requirements and other relevant provisions of Directive 1999/5/EC.

A copy of the EU Declaration of Conformity is available at: nest.com/eu/legal/eudoc.

CE¹³
0086

Nest Labs (Europe) Limited
Gordon House, Barrow Street
Dublin 4, Ireland
13
0086-CPR-599229
EN 14604:2005
Smoke Alarm Devices
Model number: 05C-E
Technical data : see User's Guide
(64-10-0030-GB)

Nest Labs (Europe) Ltd. Limited Warranty Nest Protect™ Smoke and Carbon Monoxide Alarm

THIS LIMITED WARRANTY CONTAINS IMPORTANT INFORMATION ABOUT YOUR RIGHTS AND OBLIGATIONS, AS WELL AS LIMITATIONS AND EXCLUSIONS THAT MAY APPLY TO YOU AS PART OF THE TERMS AND CONDITIONS OF SALE IN EFFECT AT THE TIME YOU PURCHASE A NEST PRODUCT.

YOUR RIGHTS AND THIS LIMITED WARRANTY

This Limited Warranty gives you specific legal rights. You may also have other legal rights that vary by state, province or jurisdiction. For example, these rights may include your rights under the EC (Certain Aspects of Sale of Consumer Goods and Associated Guarantees) Regulations 2003 and other enactments governing the sale of goods. The disclaimers, exclusions, and limitations of liability under this Limited Warranty will not apply to the extent prohibited by applicable law. For a full description of your legal rights you should refer to the laws applicable in your jurisdiction and you may wish to contact a relevant consumer advisory service. This Limited Warranty is in addition to your legal rights in relation to the Products. This Limited Warranty only applies to Products purchased and used in the European Union.

1. WHAT THIS LIMITED WARRANTY COVERS; PERIOD OF COVERAGE

Nest Labs (Europe) Ltd. ("Nest Labs") warrants to the owner of the enclosed product that the product contained in this box ("Product") will be free from defects in materials and workmanship for a period of two (2) years (or one (1) year for Factory Refurbished Products) from the date of delivery following the original retail purchase (the "Warranty Period"). If the Product fails to conform to this Limited Warranty during the Warranty Period, Nest Labs will, at its sole discretion, either (a) repair or replace any defective Product or component; or (b) accept the return of the Product and refund the money actually paid by the original purchaser for the Product. Repair or replacement may be made with a new or refurbished product or components, at Nest Labs' sole discretion, to the extent this is permitted by local laws in your jurisdiction. If the Product or a component incorporated within it is no longer available, Nest Labs may replace the Product with a similar product of similar function, at Nest Labs' sole discretion. This is your sole and exclusive remedy for breach of this Limited Warranty. Any Product that has either been repaired or replaced under this Limited Warranty will be covered by the terms of this Limited Warranty for the longer of ninety (90) days from the date of delivery or the remaining Warranty Period. This Limited Warranty is transferable from the original purchaser to subsequent owners, but the Warranty Period will not be extended in duration or expanded in coverage for any such transfer.

2. TOTAL SATISFACTION RETURN POLICY

If you are the original purchaser of the Product and you are not satisfied with this Product for any reason, you may return it at your cost in its original condition within thirty (30) days of the original purchase and receive a full refund.

3. WARRANTY CONDITIONS; HOW TO GET SERVICE IF YOU WANT TO CLAIM UNDER THIS LIMITED WARRANTY

Before being able to claim under this Limited Warranty, the owner of the Product must (a) notify Nest Labs of the intention to claim by visiting nest.com/support/eu during the Warranty Period and providing a description of the alleged failure, and (b) comply with Nest Labs' return shipping instructions. Nest Labs will have no warranty obligations with respect to a returned Product if it determines, in its reasonable discretion after examination of the returned Product, that the Product is an Ineligible Product (defined below). Nest Labs will bear all costs of return shipping to the owner and will reimburse standard shipping costs incurred by the owner, except with respect to any Ineligible Product, for which owner will bear all shipping costs.

4. WHAT THIS LIMITED WARRANTY DOES NOT COVER

This warranty does not cover the following (collectively "Ineligible Products"): Products marked as "sample" or sold "AS IS"; or Products that have been subject to: (a) modifications, alterations, tampering, or improper maintenance or repairs; (b) handling, storage, installation, testing, or use not in accordance with the User's Guide or other instructions provided by Nest Labs; (c) abuse or misuse of the Product; (d) breakdowns, fluctuations, or interruptions in electric power or the telecommunications network; or (e) Acts of God, including lightning, flood, tornado, earthquake, or hurricane. This warranty does not cover consumable parts, including batteries, unless damage is due to defects in materials or workmanship of the Product, or software (even if packaged or sold with the product). Nest Labs recommends that you use only authorised service providers for maintenance or repair. Unauthorised use of the Product or software can impair the Product's performance and may invalidate this Limited Warranty.

5. DISCLAIMER OF WARRANTIES

EXCEPT AS STATED ABOVE IN THIS LIMITED WARRANTY, AND TO THE MAXIMUM EXTENT PERMITTED BY APPLICABLE LAW, NEST LABS DISCLAIMS ALL EXPRESS, IMPLIED, AND STATUTORY WARRANTIES AND CONDITIONS WITH RESPECT TO THE PRODUCT, INCLUDING THE IMPLIED WARRANTIES OF MERCHANTABILITY, AND FITNESS FOR A PARTICULAR PURPOSE. TO THE MAXIMUM EXTENT PERMITTED BY

APPLICABLE LAW, NEST LABS ALSO LIMITS THE DURATION OF ANY IMPLIED WARRANTIES OR CONDITIONS TO THE DURATION OF THIS LIMITED WARRANTY.

6. LIMITATION OF DAMAGES

IN ADDITION TO THE ABOVE WARRANTY DISCLAIMERS, IN NO EVENT WILL NEST LABS BE LIABLE FOR ANY INDIRECT, CONSEQUENTIAL, INCIDENTAL, EXEMPLARY, OR SPECIAL DAMAGES, INCLUDING ANY DAMAGES FOR LOST DATA OR LOST PROFITS, ARISING FROM OR RELATING TO THIS LIMITED WARRANTY OR THE PRODUCT, AND NEST LABS' TOTAL CUMULATIVE LIABILITY ARISING FROM OR RELATED TO THIS LIMITED WARRANTY OR THE PRODUCT WILL NOT EXCEED THE AMOUNT ACTUALLY PAID FOR THE PRODUCT BY THE ORIGINAL PURCHASER.

7. LIMITATION OF LIABILITY

IF YOU CHOOSE TO USE THEM, ONLINE SERVICES OFFERED BY NEST LABS, INC., A US AFFILIATE OF NEST LABS ("SERVICES") PROVIDE YOU INFORMATION ("PRODUCT INFORMATION") REGARDING YOUR NEST PRODUCTS OR OTHER PERIPHERALS CONNECTED TO YOUR PRODUCTS ("PRODUCT PERIPHERALS"). THE TYPE OF PRODUCT PERIPHERALS THAT MAY BE CONNECTED TO YOUR PRODUCT MAY CHANGE FROM TIME TO TIME. WITHOUT LIMITING THE GENERALITY OF THE DISCLAIMERS ABOVE, ALL PRODUCT INFORMATION IS PROVIDED FOR YOUR CONVENIENCE, "AS IS", AND "AS AVAILABLE". NEST LABS OR ITS AFFILIATE DOES NOT REPRESENT, WARRANT, OR GUARANTEE THAT PRODUCT INFORMATION WILL BE AVAILABLE, ACCURATE, OR RELIABLE OR THAT PRODUCT INFORMATION OR USE OF THE SERVICES OR PRODUCT WILL PROVIDE SAFETY IN YOUR HOME. YOU USE ALL PRODUCT INFORMATION, THE SERVICES, AND THE PRODUCT AT YOUR OWN DISCRETION AND RISK. YOU WILL BE SOLELY RESPONSIBLE FOR (AND NEST LABS AND ITS AFFILIATE DISCLAIM) ANY AND ALL LOSS, LIABILITY, OR DAMAGES, INCLUDING TO YOUR WIRING, FIXTURES, ELECTRICITY, HOME, PRODUCT, PRODUCT PERIPHERALS, COMPUTER, MOBILE DEVICE, AND ALL OTHER ITEMS AND PETS IN YOUR HOME, RESULTING FROM YOUR USE OF THE PRODUCT INFORMATION, SERVICES, OR PRODUCT. PRODUCT INFORMATION PROVIDED BY THE SERVICES IS NOT INTENDED AS A SUBSTITUTE FOR DIRECT MEANS OF OBTAINING THE INFORMATION.

8. VARIATIONS THAT MIGHT APPLY TO THIS LIMITED WARRANTY

Some jurisdictions do not allow limitations on how long an implied warranty lasts or specific exclusions, so some of the limitations set out above may not apply to you.

9. CONTACT INFORMATION

Please direct any questions about this Limited Warranty to Nest Labs (Europe) Ltd. at the address located at: nest.com/eu/contact.

64-30-0030-GB

